



# ALUMINUM TRENCH SHIELDS

## 3" MOD Series

The Pro-Tec Equipment 3" MOD Series is a modular aluminum trench shield system that is lightweight and easily transported via pick-up truck. It can be used as a 2-, 3- or 4-sided system with existing components and can be changed on the fly at a jobsite to meet the job's requirements.

### Standard features:

- Smooth wall panel design
- Foam filling – prevents soil and water buildup
- Accepts telescoping spreaders (ECP Spreaders)
- Bottom panels can be removed
- 2-way corner posts allow, 2-, 3- or 4-sided configurations
- Professional Engineer Certified to meet or exceed O.S.H.A. requirements

### MOD Series Options

- Aluminum built-in knife edge
- Steel bolt-on knife edge
- Wheel kits
- High Clearance Arch
- Adjustable legs
- Stacking units
- Custom sizes



## Quick & Easy Assembly

3-sided shown

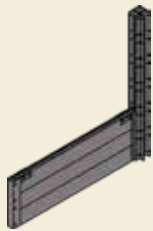

Attach corner post to one panel. Install pins with handles on the outside.

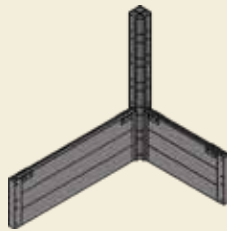

Set back panel, creating a 90° angle. Install all pins and keepers.

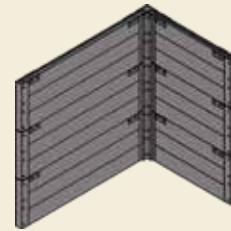

Stack panels to desired height.



Install lift-eyes then 2nd and 3rd corner post.



Install opposite panels to desired height. Add 4th corner post.



Install spreaders at required locations (see tabulated data).

3" Mod Series Trench Shields are easily handled by a rubber-tired backhoe loader.

### Corner Post (2-way)

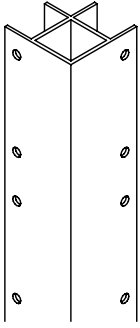

Model	Length	Weight (Lb.)
PCC-24	24"	19
PCC-48	48"	36
PCC-72	72"	50
PCC-96	96"	65
PCC-120	120"	85

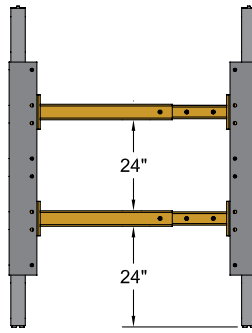

End View  
Sectional corner post with adjustable struts

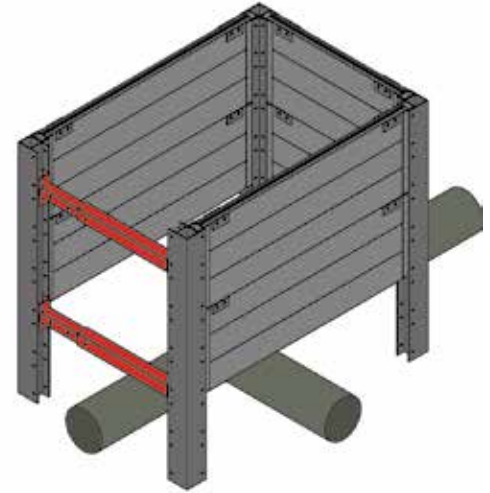

Panels omitted to allow for T-connections or existing utilities

### Corner Post (3-way)

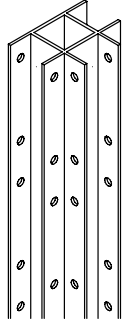

Model	Length	Weight (Lb.)
PCC3-24	24"	24
PCC3-48	48"	49
PCC3-72	72"	70
PCC3-96	96"	91
PCC3-120	120"	116

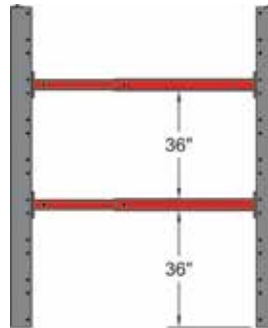

End View  
Full length corner post with adjustable struts

### 3" MOD Panel Depth Chart

Width x Length (ft.)	Weight (Lb.)	Maximum Depth of Cut (ft.)		
		B	C -60	C-80
PCP 2 x 4	60	40	30	23
PCP 2 x 6	90	27	21	16
PCP 2 x 8	120	21	16	12
PCP 2 x 10	140	17	13	10
PCP 2 x 12	170	15	11	9

Additional panels sizes are available



### Telescoping Adjustable Spreader

Model	Adjustment (I.D.)	Weight (Lb.)
EPC-2436	24" to 36"	28
EPC-3660	36" to 60"	43
EPC-4872	48" to 72"	48
EPC-6096	60" to 96"	78
EPC-72120	72" to 120"	105
EPC-84144	84" to 144"	127



### PRO-TEC EQUIPMENT

4837 West Grand River Ave  
Lansing, MI 48906  
Phone: 1-800-292-1225  
Fax: (517) 827-3263  
www.pro-tecequipment.com

The information in this brochure is presented in good faith to assist the user in determining whether our products are suitable for his/her application. No warranty or representation, however, is intended or made, nor is protection from any law or patent to be inferred, and all patent rights are reserved. Job site photos are strictly intended for general product information only and may not comply with all applicable safety standards. Always refer to manufacturer's specific tabulated data, O.S.H.A. 29 CFR 1926 Subpart P for excavation and all applicable safety standards prior to each use. ©2018 Pro-Tec Equipment. All rights reserved.

